

Bakströmsrelä

Generator

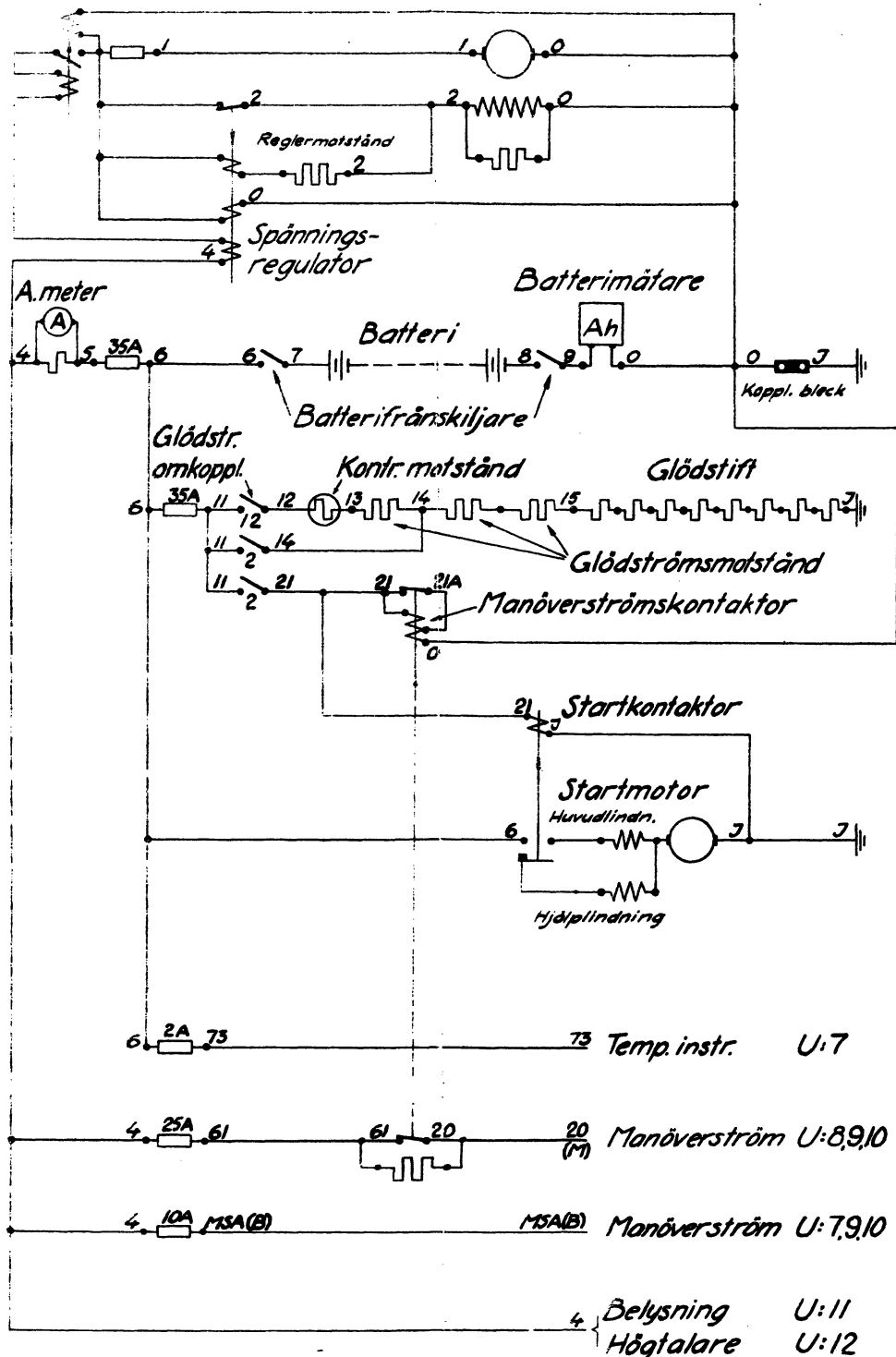

Schema U:6

Motorkontroll

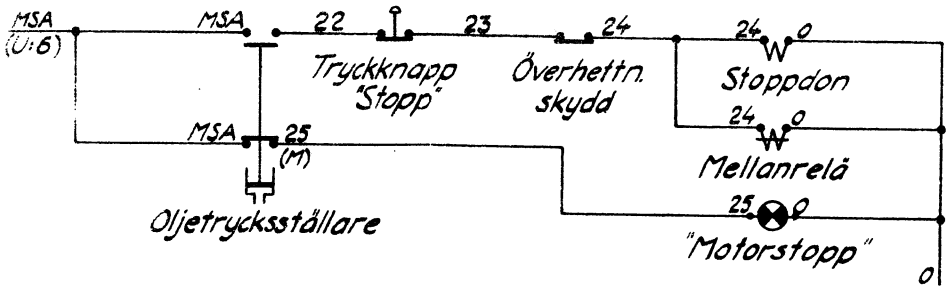

Temperaturmätinstrument

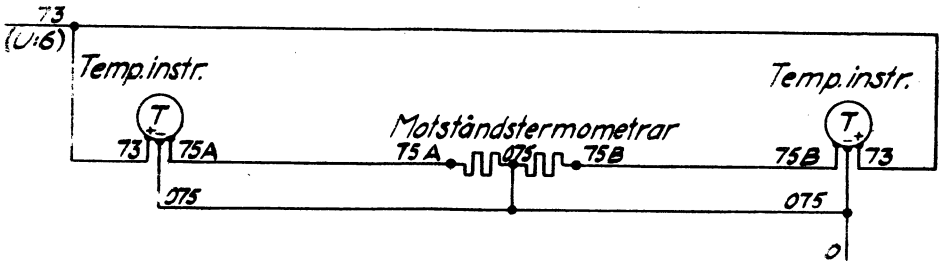

Hastighetsmätare

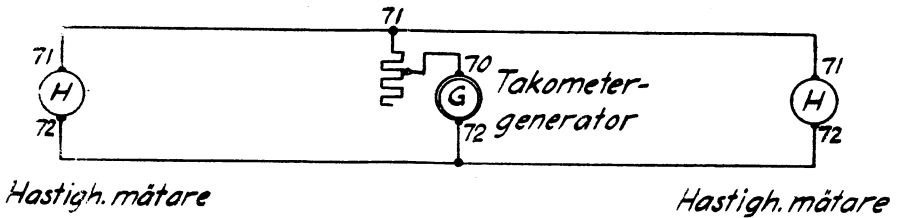

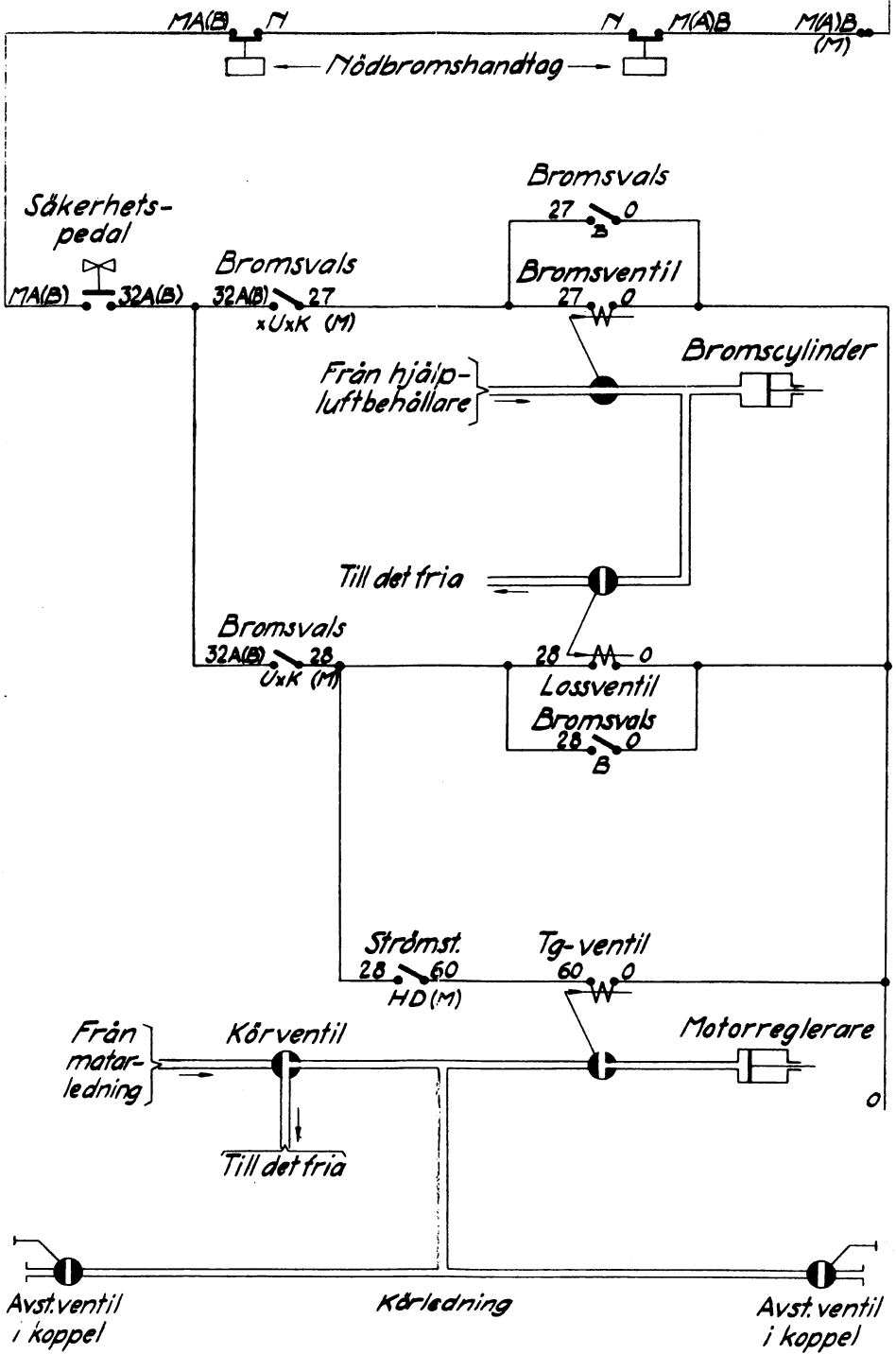

Schema U:8

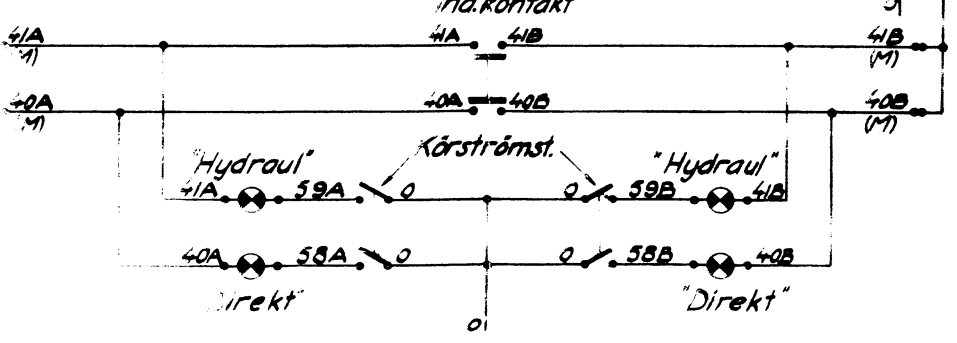
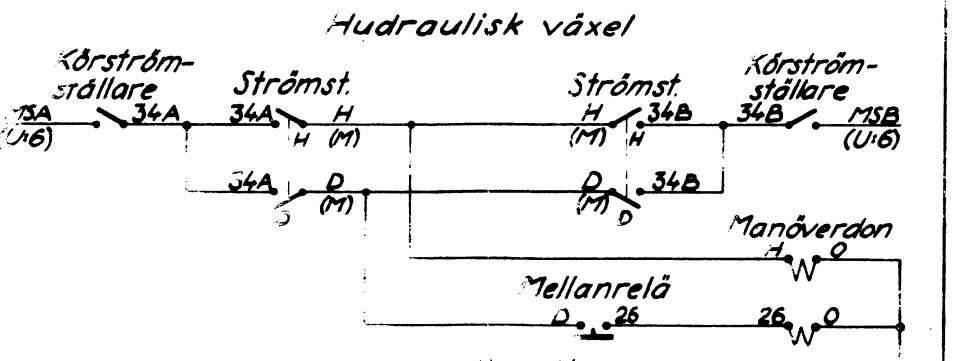
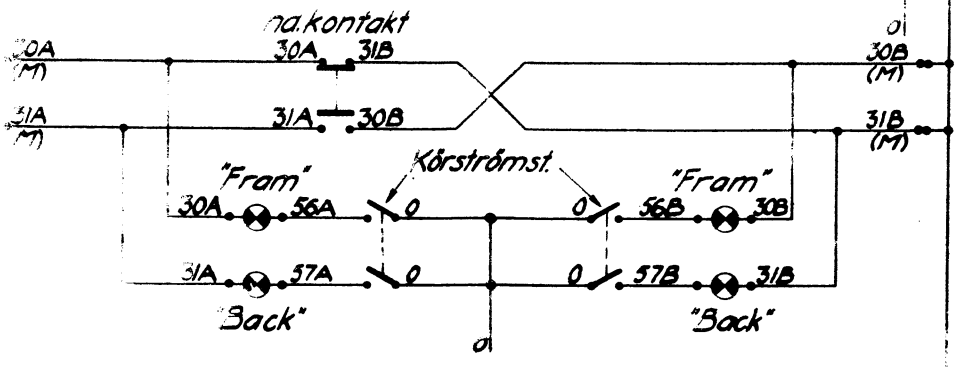
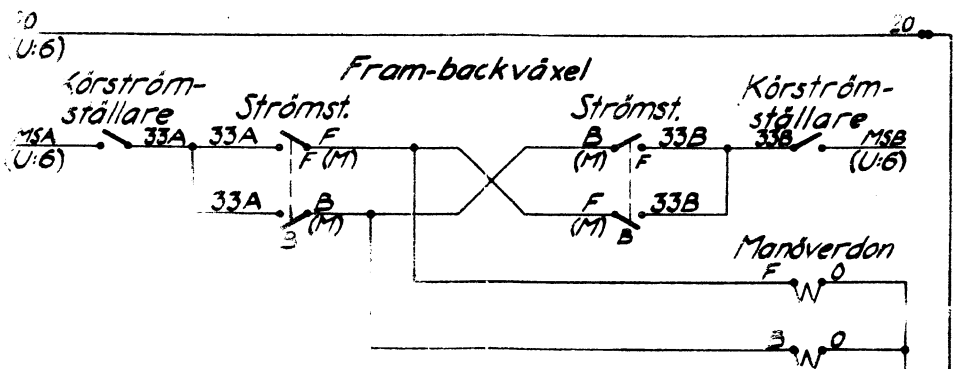

Schema u:9

Dörrmanövrering

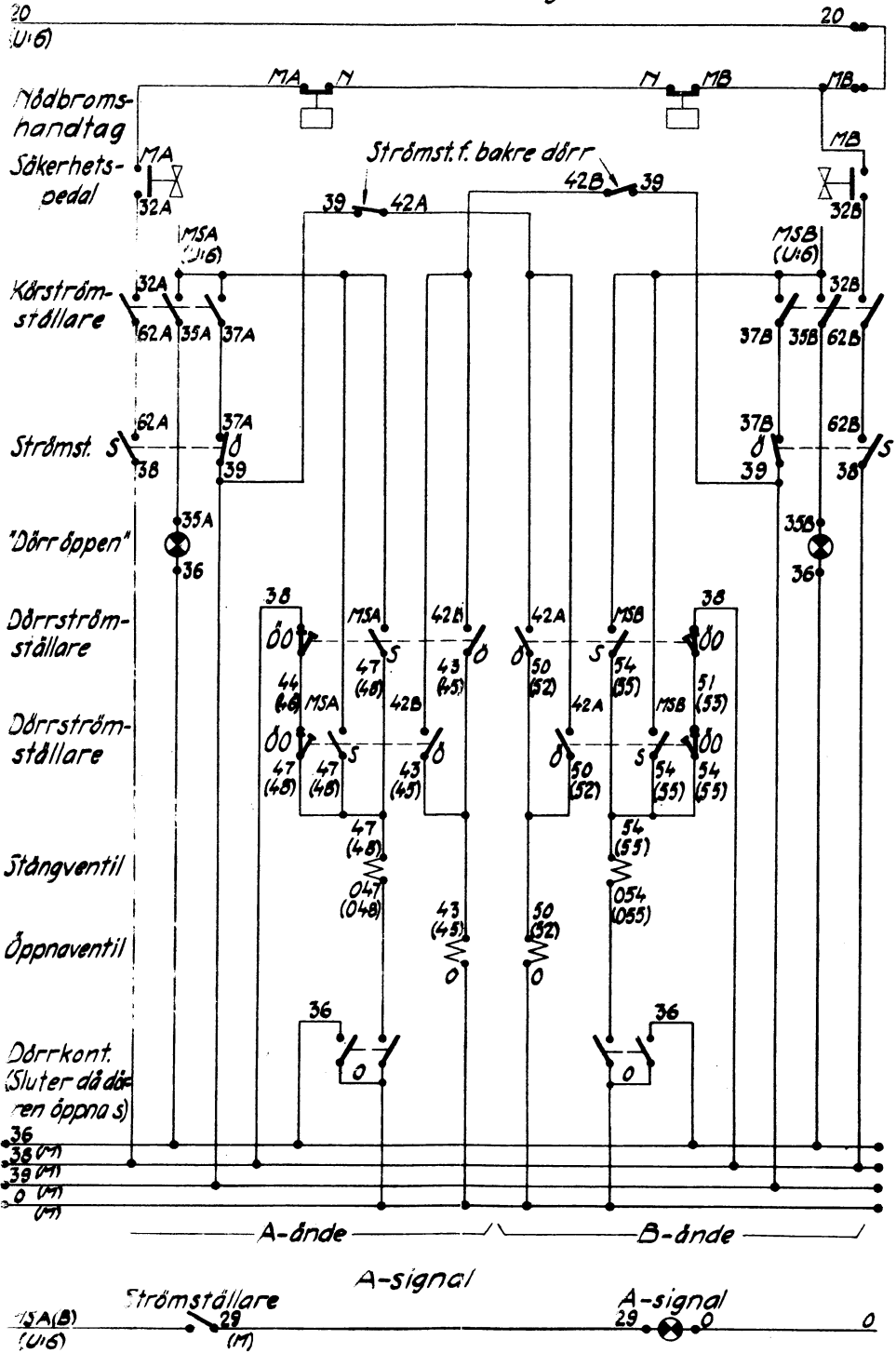

Schema U:10

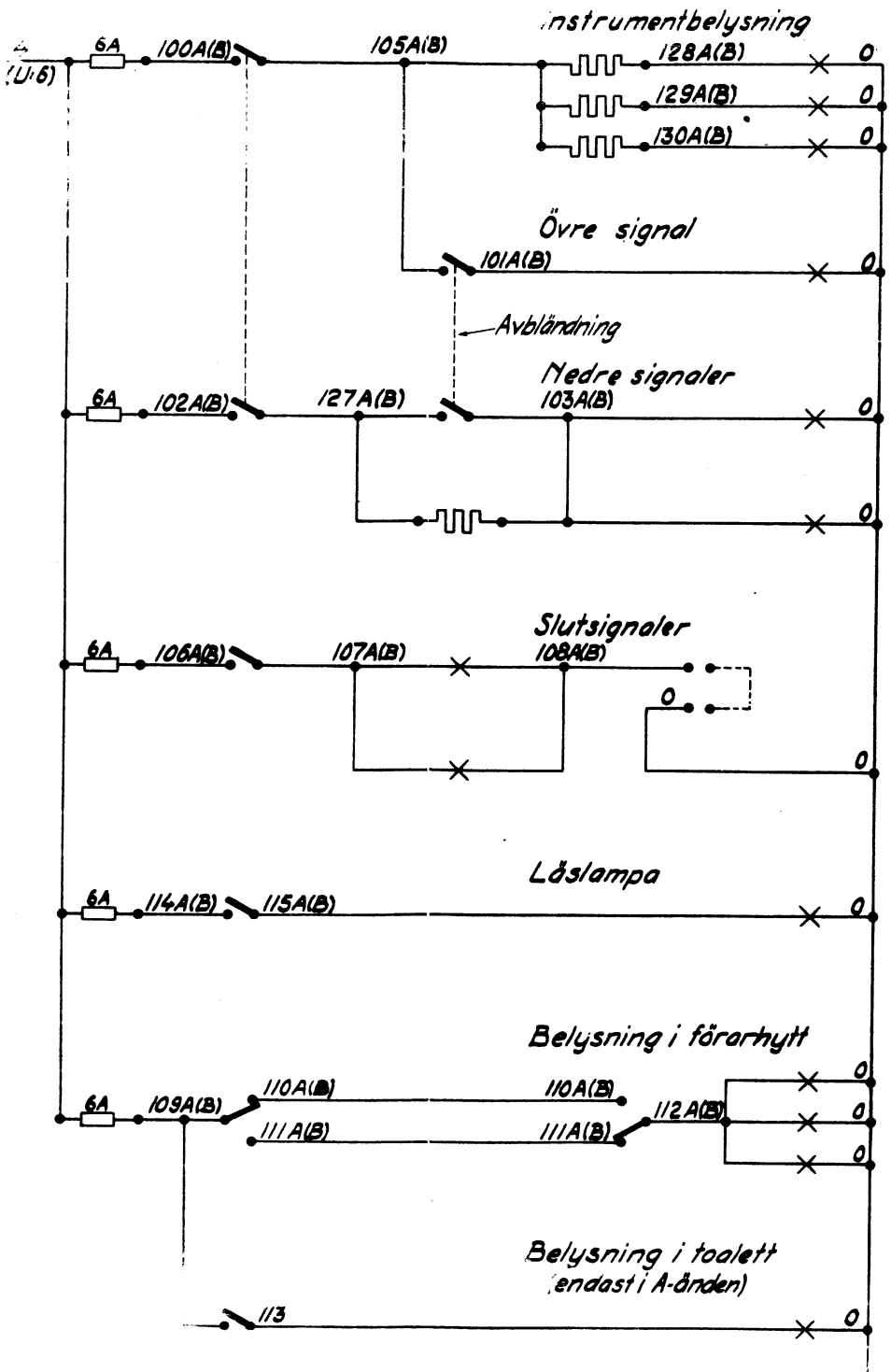

Schema U:11

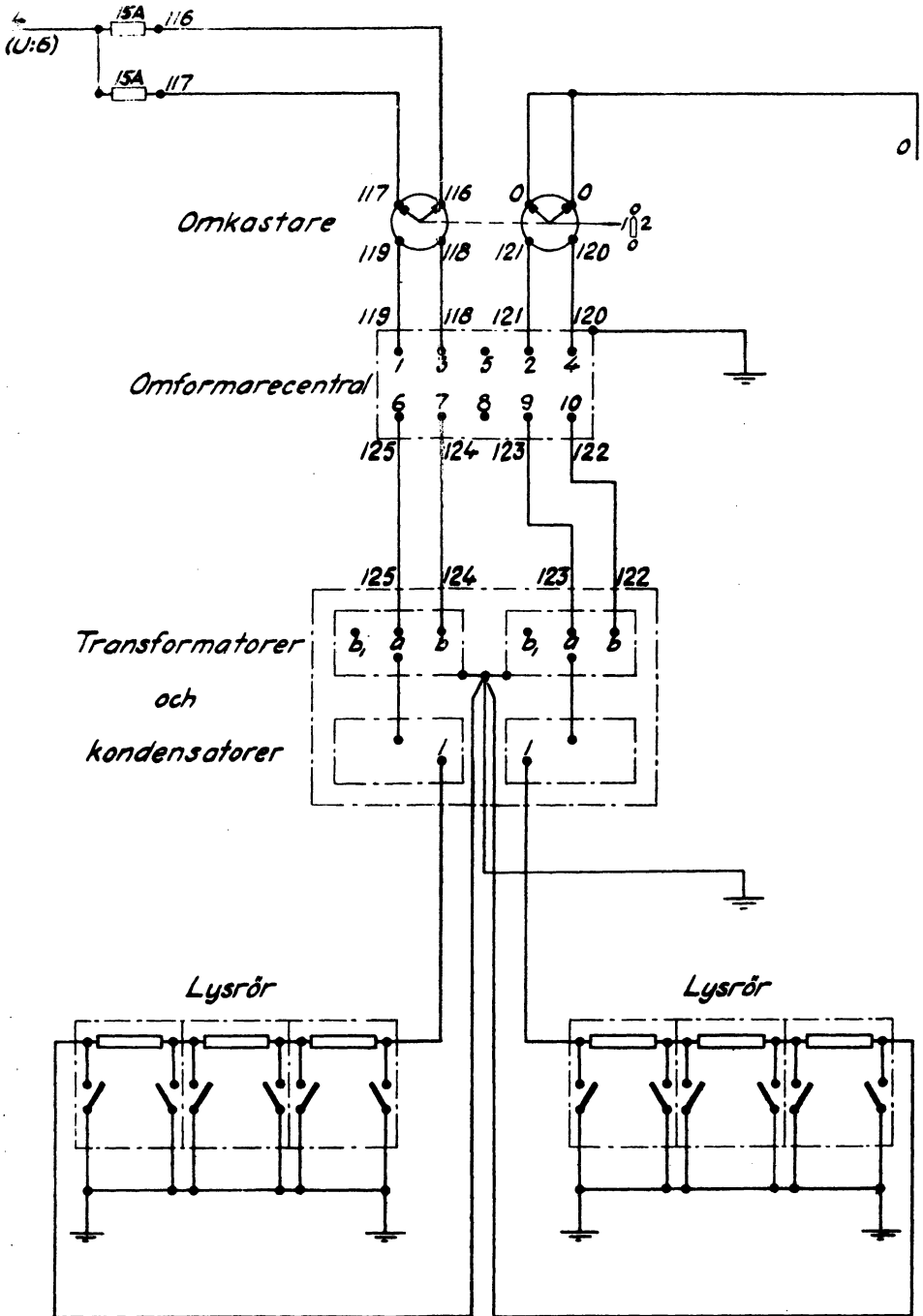

Schema U:11b

Nödbromshandtag

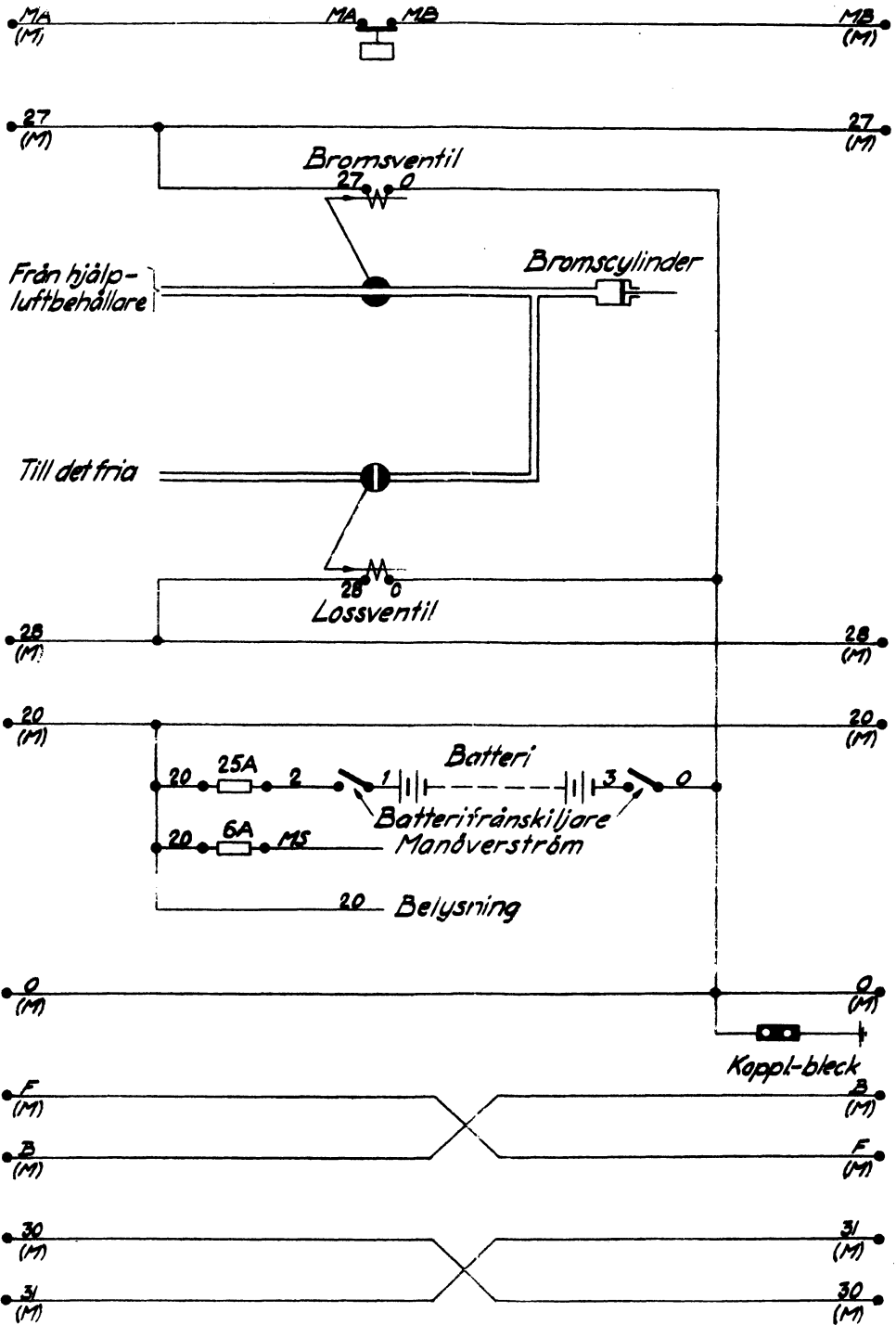

Schema U:13

Dörrmanövrering

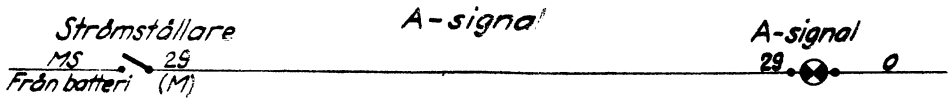
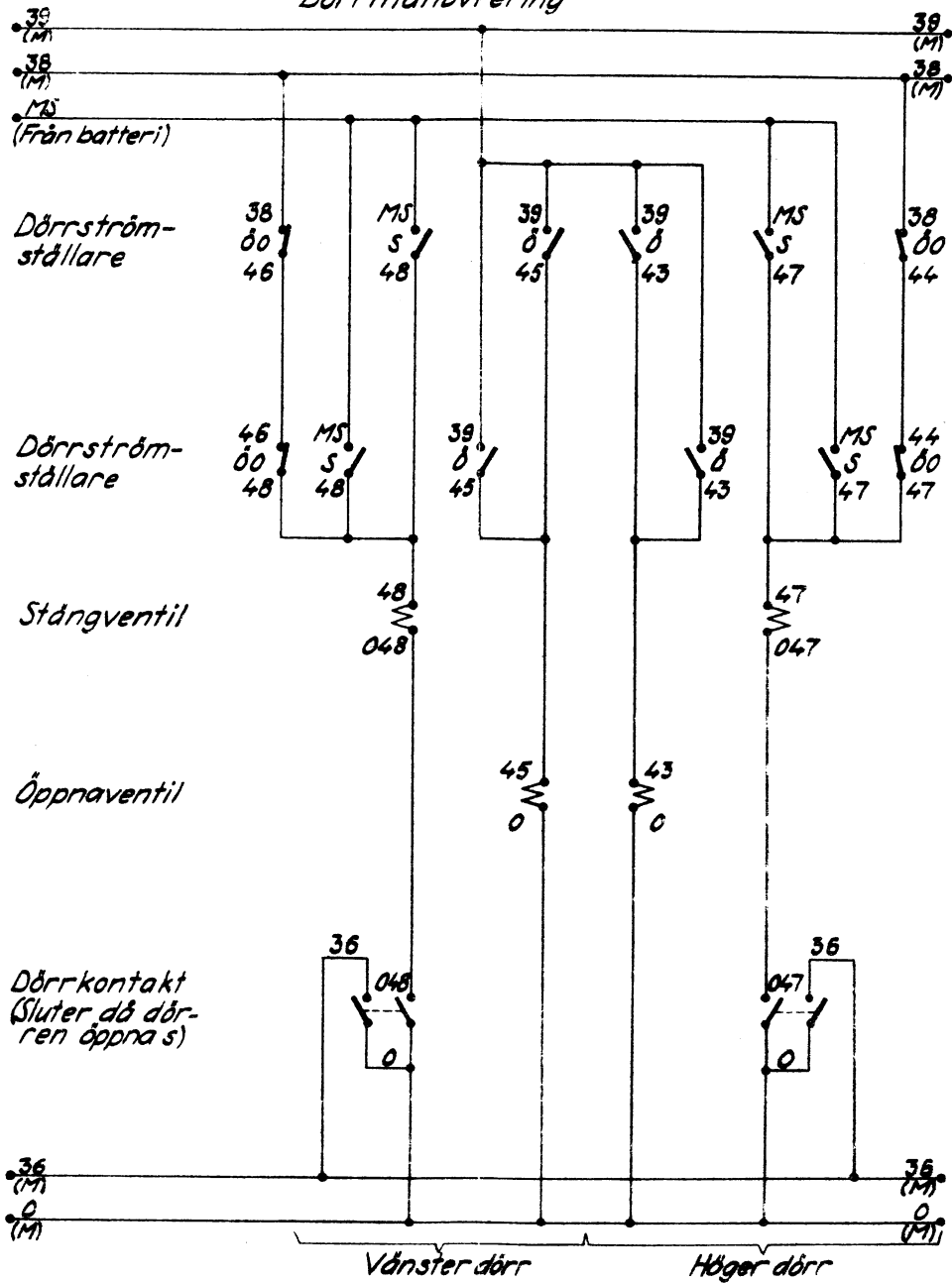

Schema U:13 b

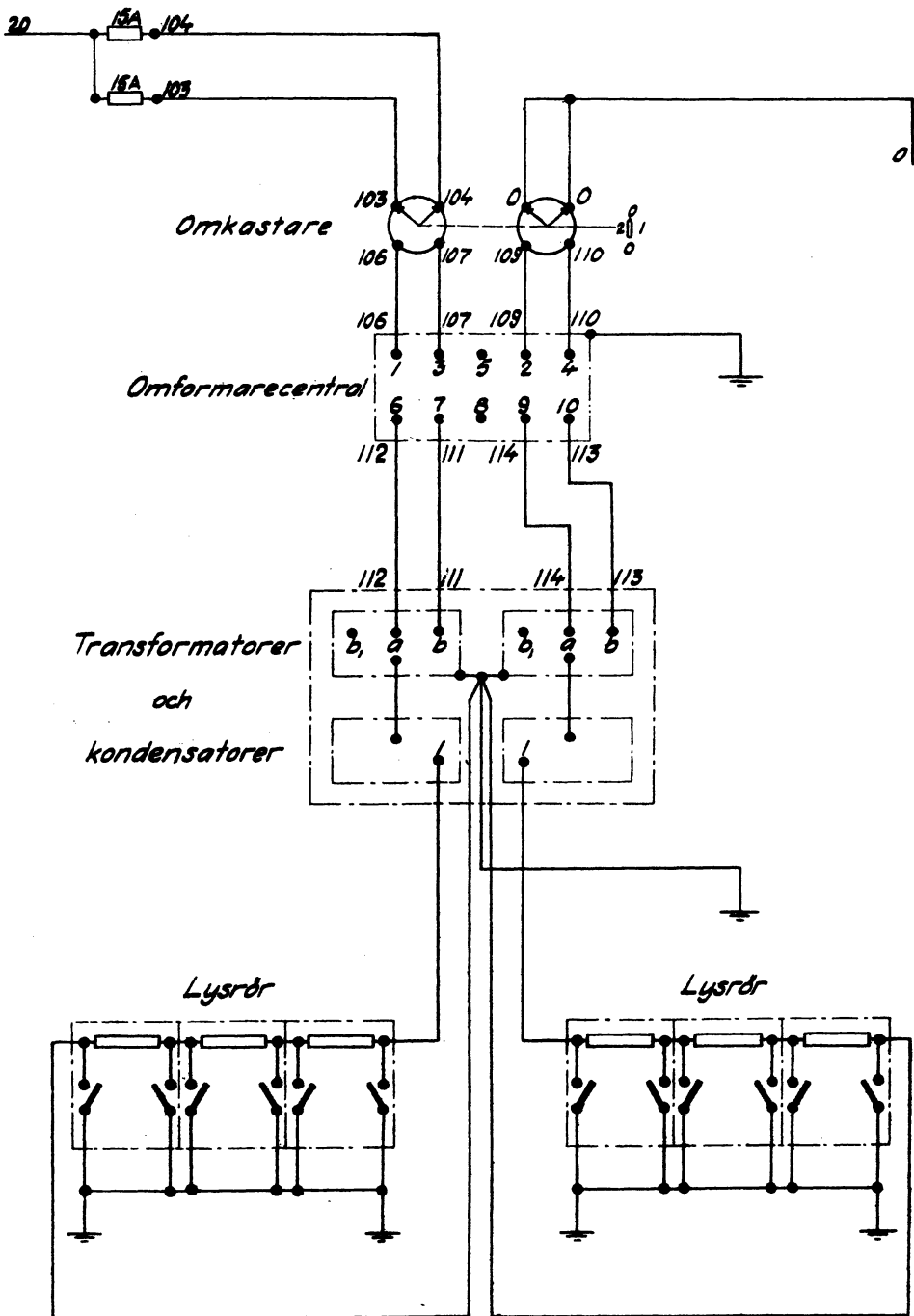

Schema U:13c

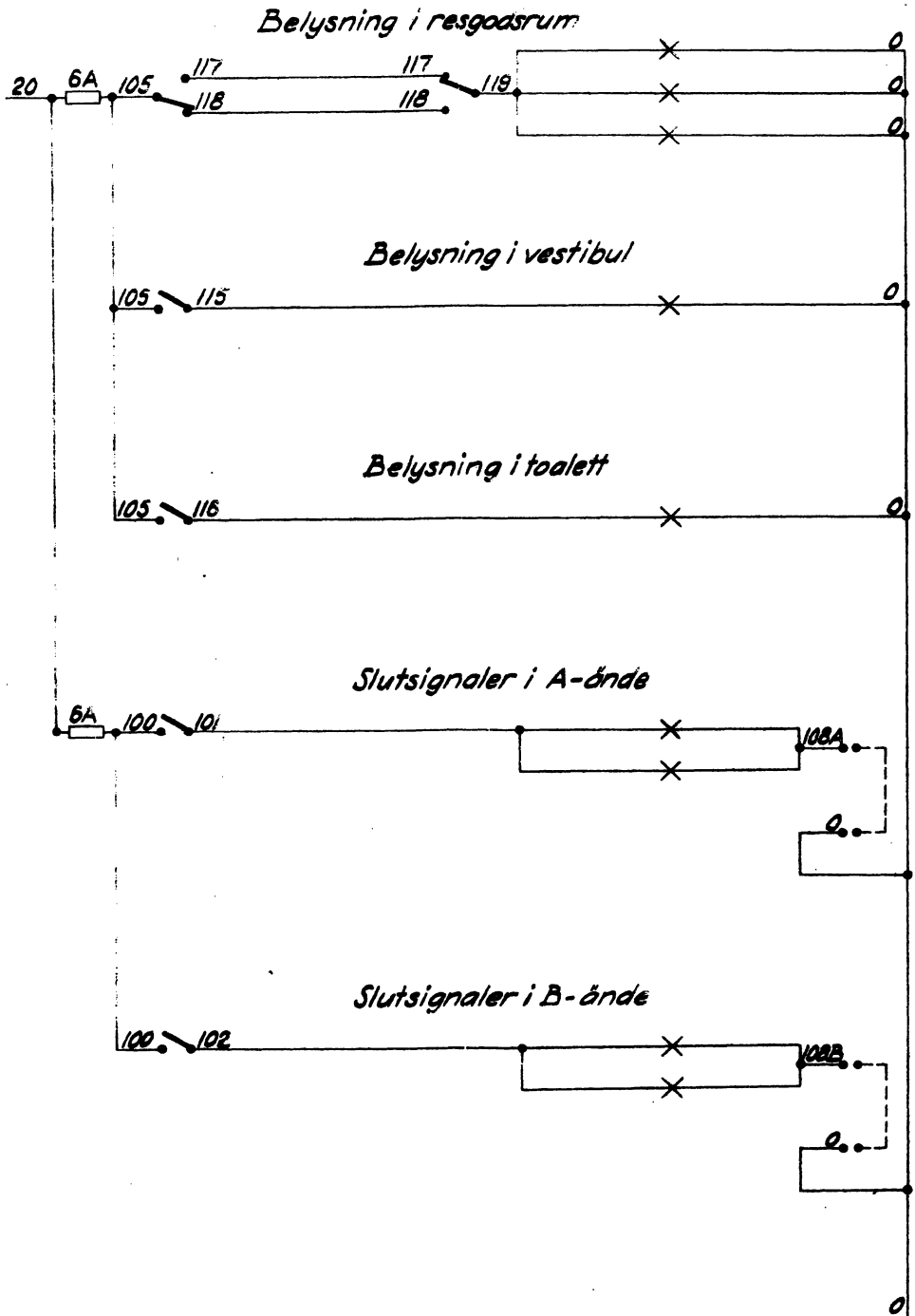

Schema U:13d

Nödbromsananatag

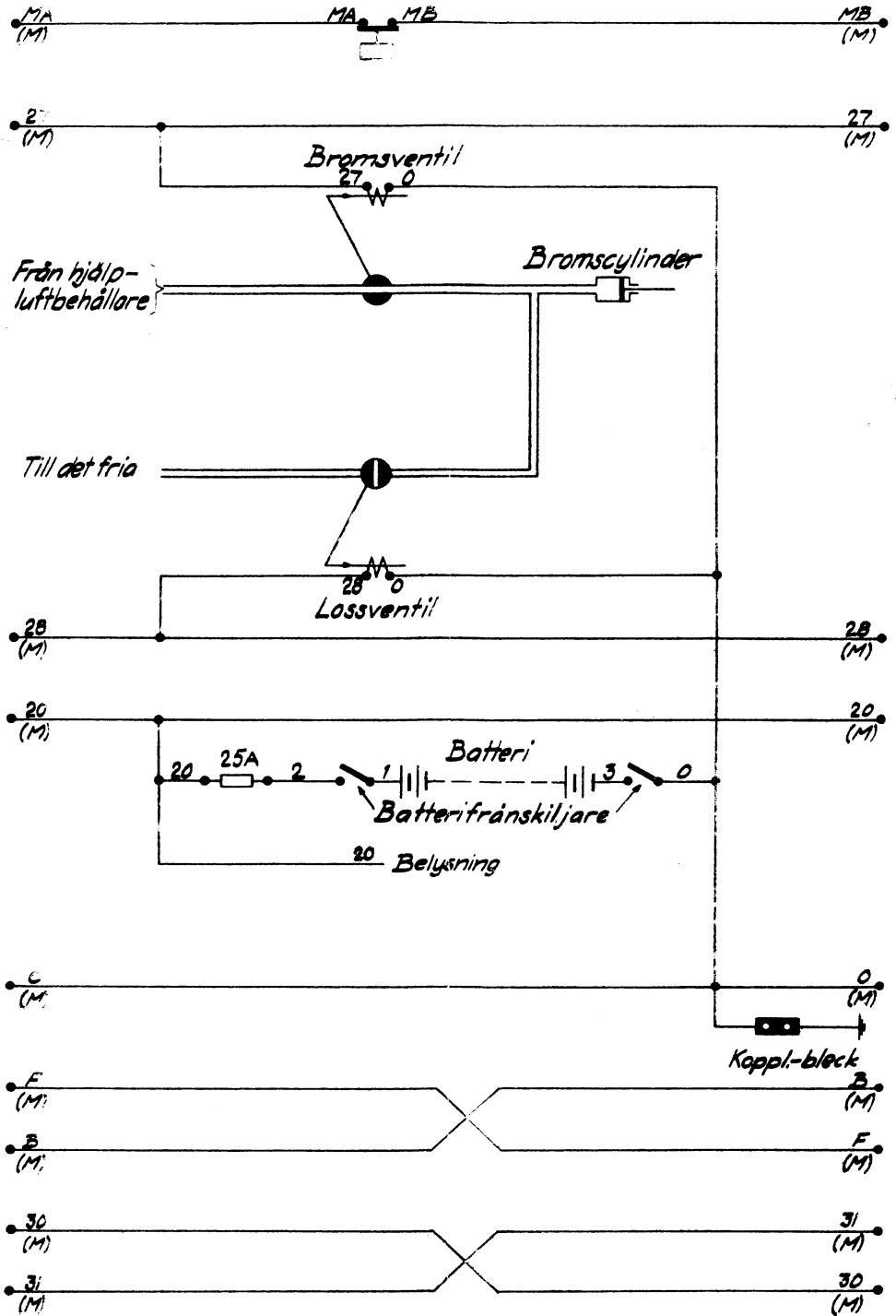

Schema U:13e

Belysning i postkupe

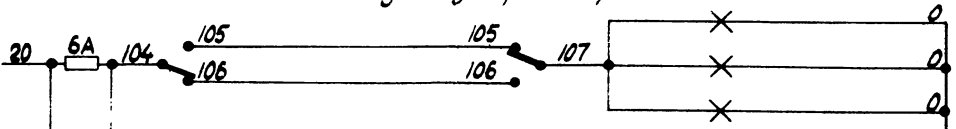

Belysning i värdefack

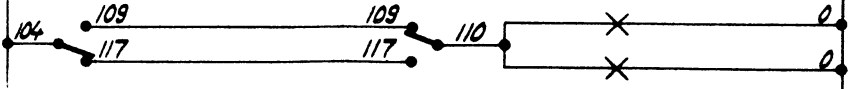

Belysning i toalett

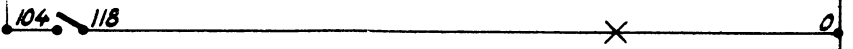

Slutsignaler i A-ände

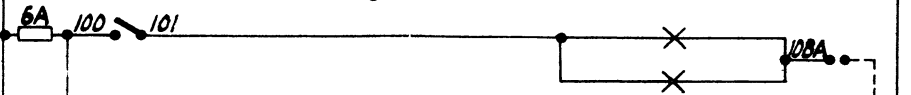

Slutsignaler i B-ände

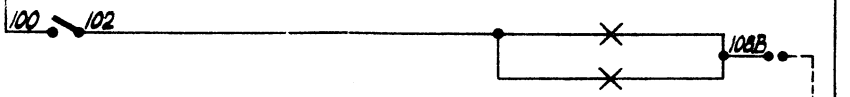

Belysning i resgodsvardelning

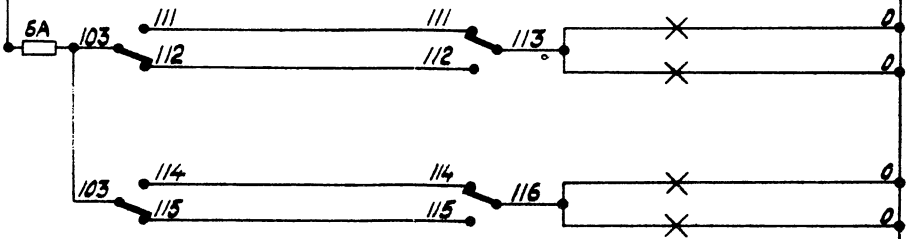

Schema U:13f