

# HÖLÖ

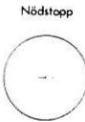

# VAGNHÄRAD

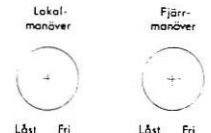

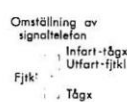
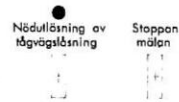
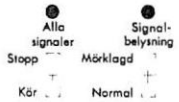
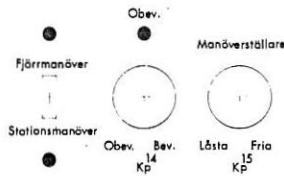
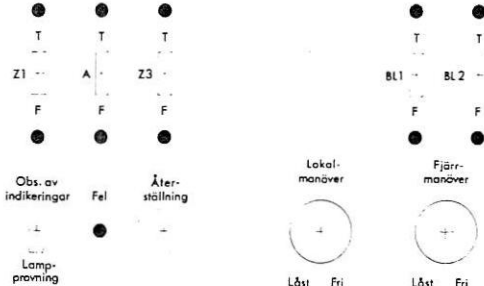
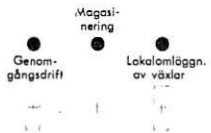
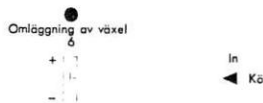
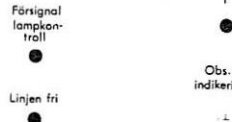
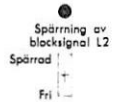
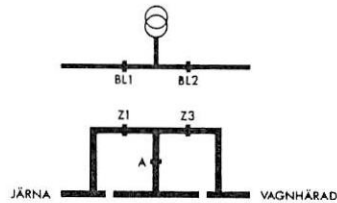
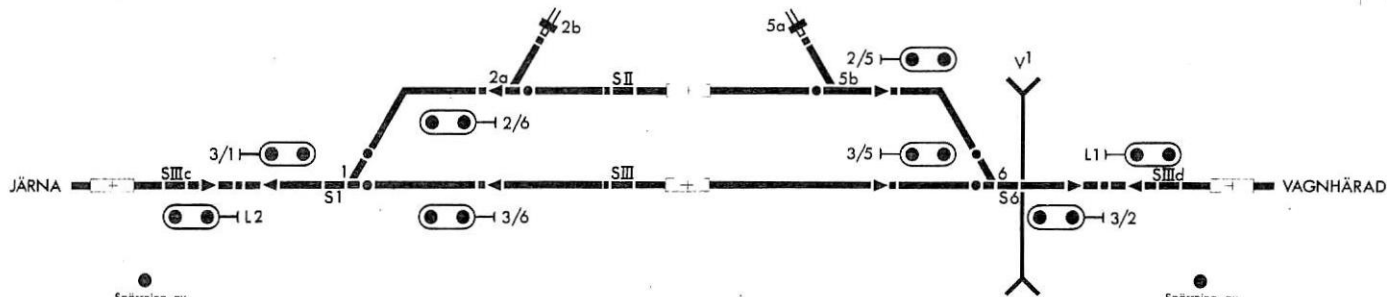
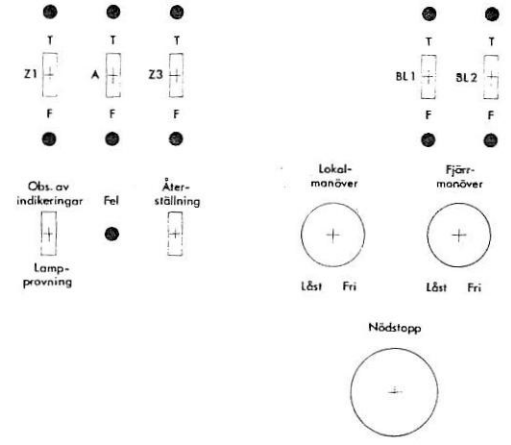
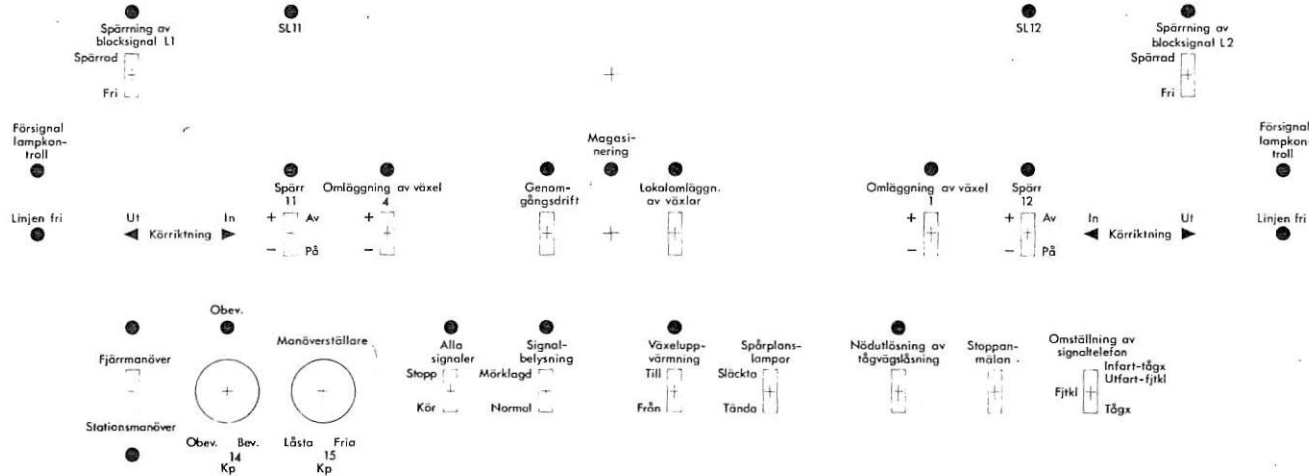
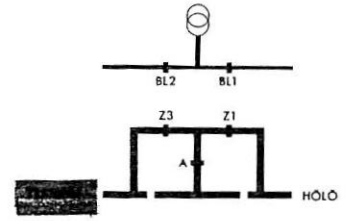
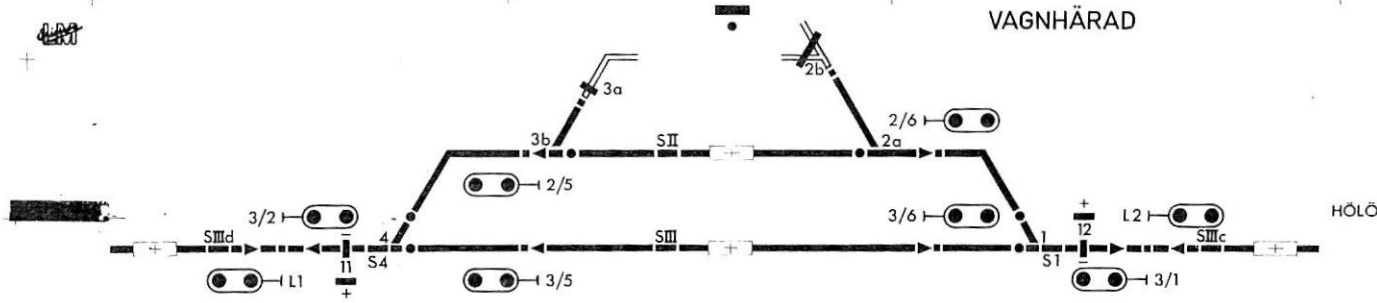
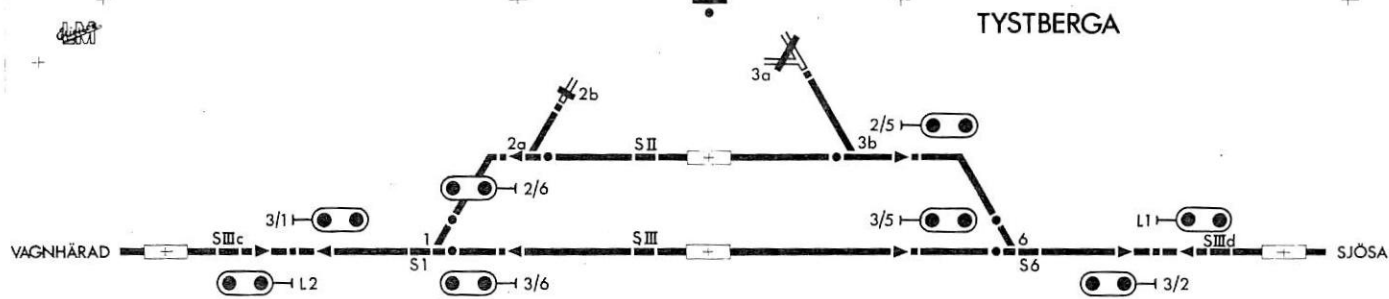

TYSTBERGA

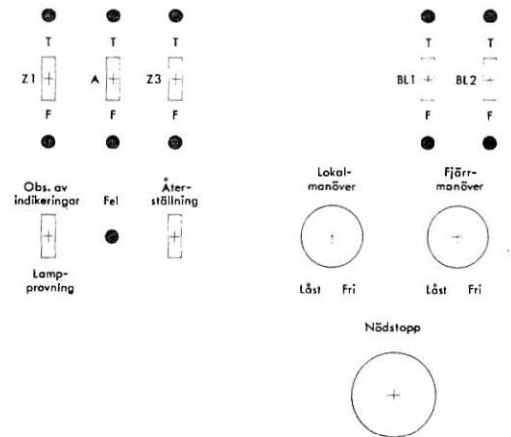
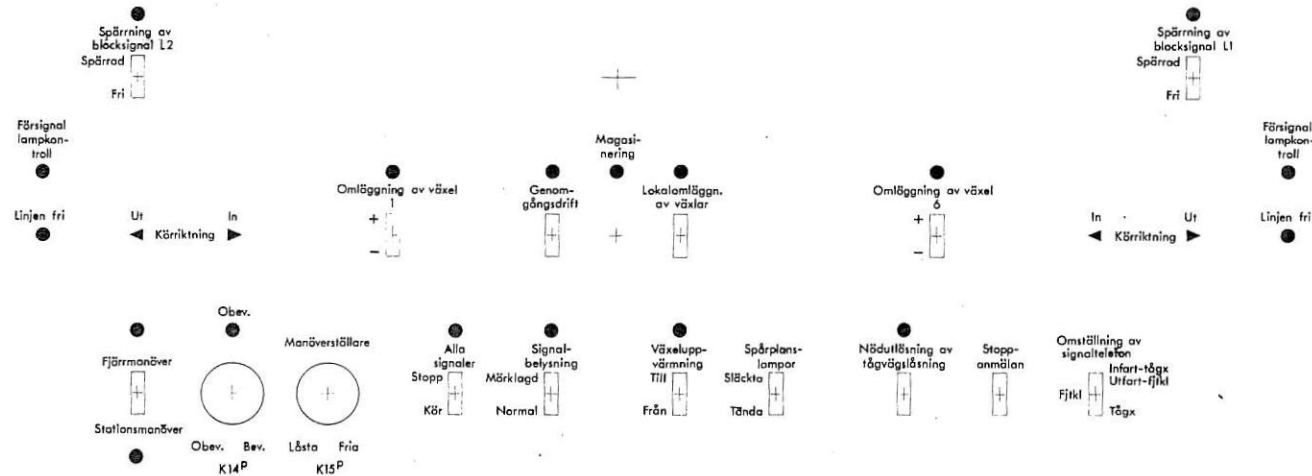
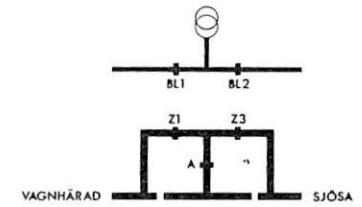

SJ 59 F

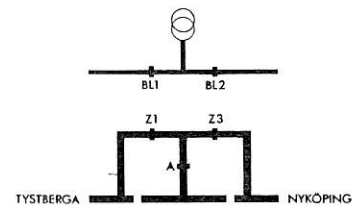
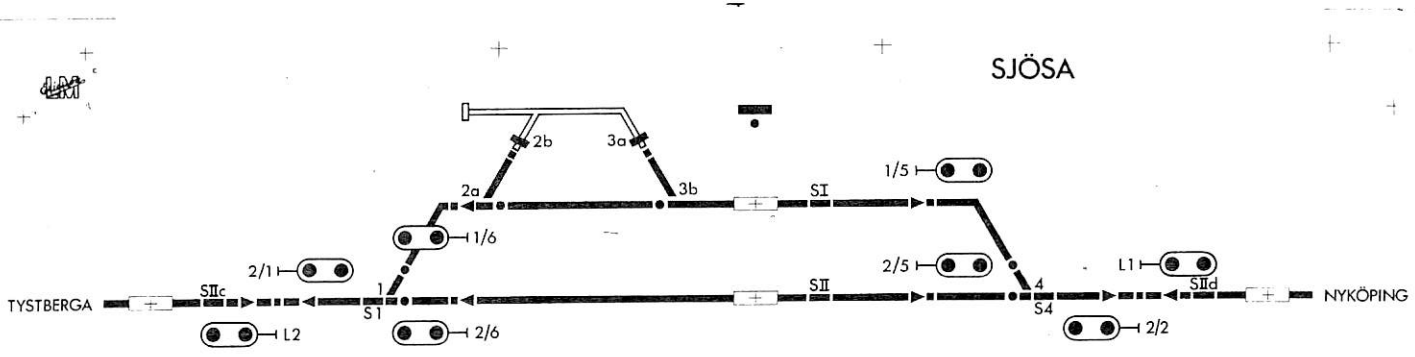

Spärrning av blocksignal L2  
Spärrad  
Fri

Försignal lampkontroll  
Linjen fri

Ut  
Körriktning  
In

Omläggning av växel  
+  
-

Genomgångsdrift

Magasiner

Lokalomläggning av växlar

Omläggning av växel  
+  
-

In  
Körriktning  
Ut

Försignal lampkontroll  
Linjen fri

Spärrning av blocksignal L1  
Spärrad  
Fri

Z1  
A  
Z3  
F  
F  
F

Obs. av indikeringar  
Lampprovning

Fel

Återställning

Lokalmanöver  
Läst  
Fri

Fjärrmanöver  
Läst  
Fri

Nödstopp

Obev.  
Fjärrmanöver  
Stationsmanöver

Mänöverställare  
Obev.  
Bev.  
Lästa  
Fria  
K14 P  
K15 P

Alla signaler  
Stopp  
Kör

MSRklagd  
Normal

Signalbelysning

Växeluppvärmning  
Till  
Från

Spårplanslampor  
Släckta  
Tända

Nödutlösning av tågväglåsning

Stopp-anmälan

Omställning av signaltelefon  
Fjtkl  
Infart-lågx  
Utart-fjtkl  
Tågx

SJ 59 F

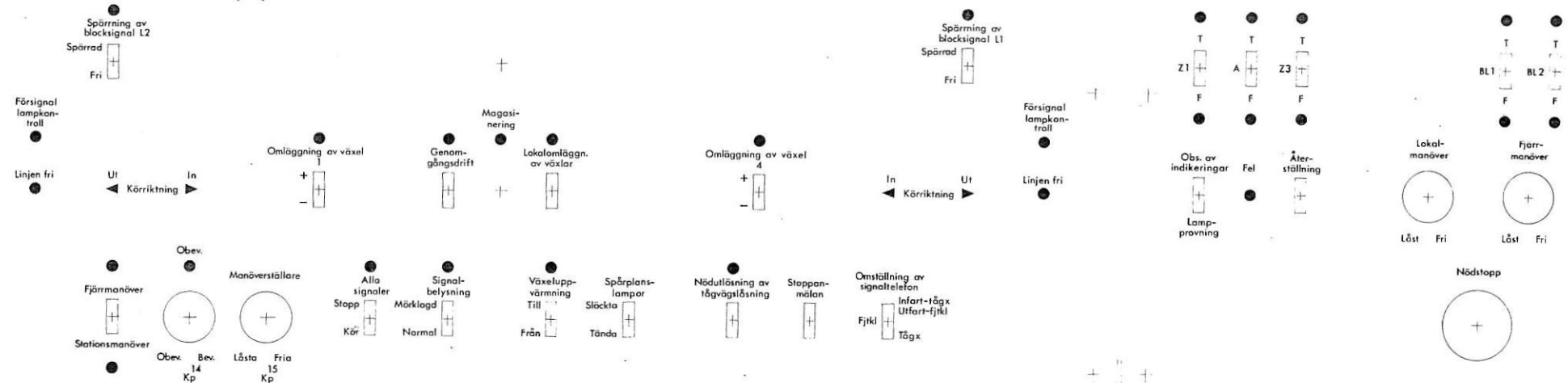
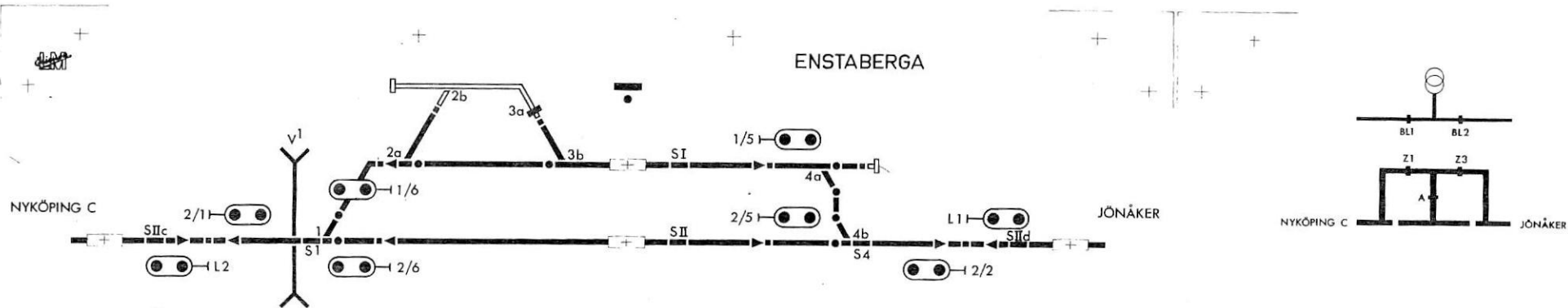

SJ 59F

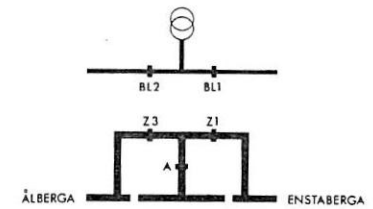
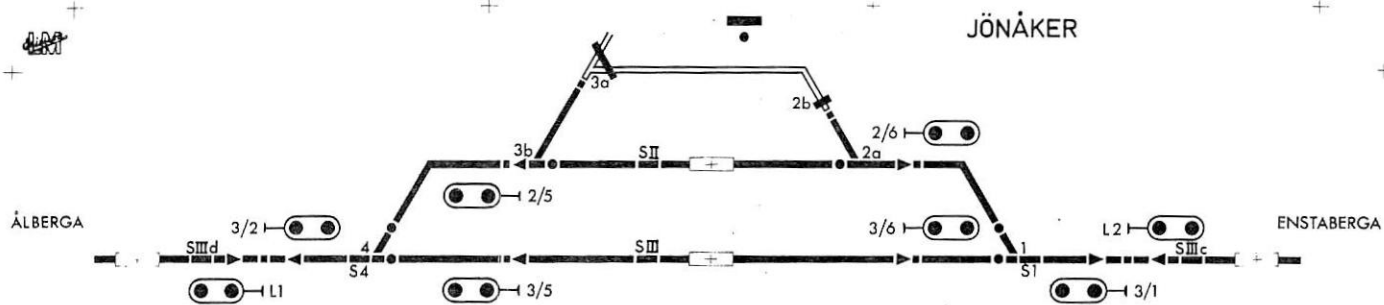

Spärring av blocksignal L1  
Spärrad  
Fri

Försignal lampkontroll  
Linjen fri

Ut  
Körriktning  
In

Omläggning av växel  
+  
-

Genomgångsdrift

Magasinering

Lokalomläggn. av växlar

Omläggning av växel  
+  
-

In  
Körriktning  
Ut

Försignal lampkontroll  
Linjen fri

Spärring av blocksignal L2  
Spärrad  
Fri

Z1  
A  
Z3

Obs. av indikeringar  
Lampprovning

Fel  
Återställning

Lokalmanöver  
Fjärrmanöver

Löst  
Fri

Löst  
Fri

Nådstopp

Manöverställare

Fjärrmanöver  
Stationsmanöver

Obes.  
14  
Kp

Obes.  
15  
Kp

Lösta  
Fria  
Kp

Alla signaler  
Stopp  
Kör

Signalbelysning  
Märklagd  
Normal

Växeluppvärmning  
Till  
Från

Spårplanslampor  
Släckta  
Tända

Nädulösning av tågvägslösning

Stoppanmälan

Omställning av signaltelefon  
Infart-tåg  
Utart-fjtkl  
Tåg

449

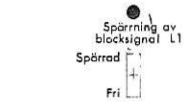
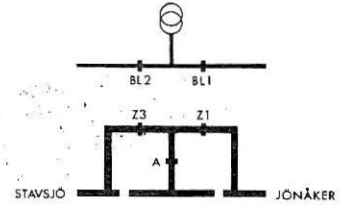
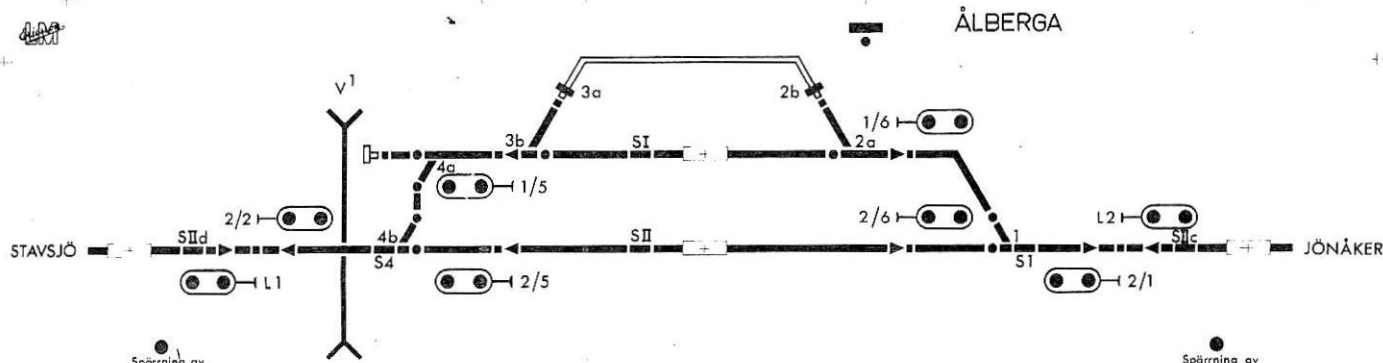

Försignal lampkontroll

Linjen fri

Ut Körriktning In



Magasinering

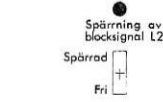

Försignal lampkontroll

Linjen fri

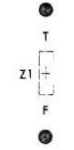

Obs. av indikeringar  
Lampprovning



Fel

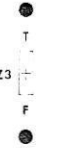

Återställning

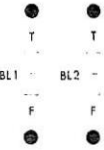

Fjärrmanöver

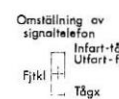
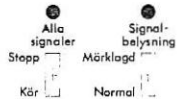
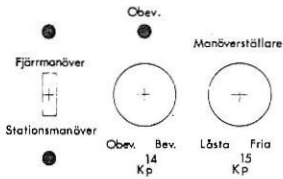

# KROKEK

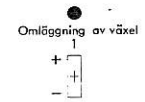
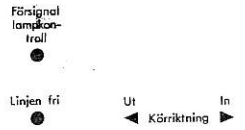
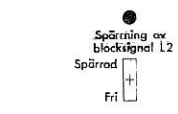
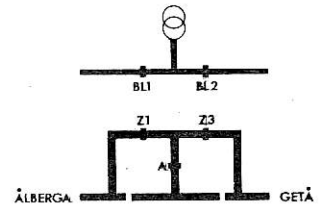
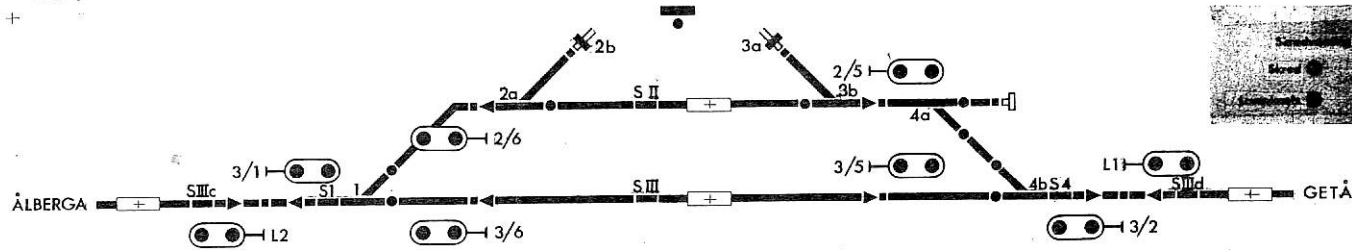

Magbälte

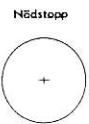
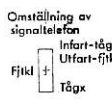
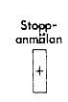
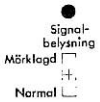
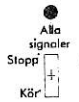
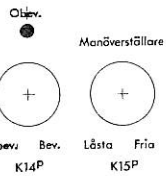
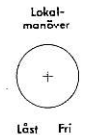
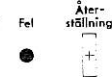
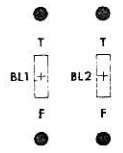
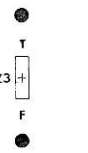
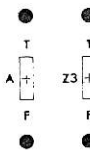
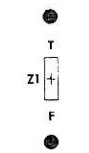
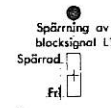
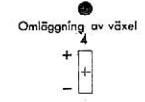

SJ 59 F

